



USER MANUAL



DESD8LW-V2 8L SMART DESSICANT DEHUMIDIFIER WITH HEATER

Thank you for choosing electriQ

Please read this user manual before using this innovative dehumidifier and keep it safe for future reference.

SETTLING IN OK?

We hope this has been helpful to you.

We would love to see how you're getting on with your new purchase, so please share any snaps you have on the platform of your choice below.

Our community awaits your uploads - Snap, tag and hashtag away!



@electriQUK

#electriQUK

WE'RE HERE TO HELP

Should you have any problems or questions with your purchase, please contact a member of our customer service team.

☎ 0330 390 3061

✉ support@electriQ.co.uk

Mon-Fri | 9am to 5pm

Unit 2A, Trident Business Park,
Neptune Way, Leeds Road,
Huddersfield, HD2 1UA

CONTENTS

SAFETY INSTRUCTIONS	4
FEATURES	7
PARTS	8
CONTROL PANEL	9
QUICK REFERENCE GUIDE	11
OTHER FEATURES	12
POSITIONING THE DEHUMIDIFIER	12
WATER DRAINAGE	13
SET UP AND USE OF APP	14
CARE AND MAINTENANCE	24
TROUBLESHOOTING	25
TECHNICAL SPECIFICATION	28

SAFETY INSTRUCTIONS

IMPORTANT

- Carefully read the instructions before operating the unit.
- This appliance only intended for use in an indoor domestic environment. Any other use is not recommended by the manufacturer and may cause fire, electrical shock or other injuries to person or damage to property.
- Rating: This unit must only be connected to an AC 220-240V / 50 Hz earthed outlet. Installation must be in accordance with the regulations of the country where the unit is used.
- If you are in any doubt about the suitability of your electrical supply, have it checked and, if necessary, modified by a qualified electrician.
- This dehumidifier has been tested and is safe to use. However, as with any electrical appliance – care must be taken during use.
- Disconnect the power from the appliance before dismantling, assembling or cleaning.
- Avoid touching any moving parts of the appliance.
- Never insert fingers, pencils or any other objects through the guard.
- This appliance is not intended for use by persons (including children) with reduced physical, sensory or mental capabilities. It is also not intended for use by those with a lack of experience and knowledge unless they have been given supervision or instruction concerning the use of the appliance by a person responsible for their safety.
- Do not leave children unsupervised with this appliance.
- Do not clean the unit by spraying it or immersing it in water.
- Never connect the unit to an electrical outlet using an extension cord. If a power outlet is not available, one should be installed by a qualified electrician.
- Never operate this appliance if the cord, power adapter or plug is damaged. Ensure the power cord is not stretched or exposed to sharp object/edges.
- A damaged power supply cord should be replaced by the manufacturer or a qualified electrician in order to avoid a hazard.
- Any service other than regular cleaning or filter replacement should be performed by an authorised service

representative. Failure to comply could result in a voided warranty.

- Do not use the appliance for any purpose other than its intended use.
- Do not tilt the unit while in use. The unit is designed to work only in a vertical position. This dehumidifier must always be stored upright, otherwise irreparable damage may be caused.
- This unit will still operate for approximately 10 minutes after pressing the power button to turn off. This is normal and ensures the desiccant wheel is drained of water. Avoid restarting the dehumidifier until 5 minutes have passed after being turned off.
- Never use the mains plug as a switch to start or turn off the dehumidifier. Use the provided power button located on the control panel.
- Always place the unit on a dry and stable surface.
- The appliance should not be installed in a laundry or wet room where the humidity is higher than 85% RH. This unit should be operated at an ambient temperature between 5°C and 35°C.
- Do not dry laundry directly above the unit. To prevent water from

entering the dehumidifier, laundry should be placed at least 40 cm away from your dehumidifier.

- Do not place the unit next to heat sources (e.g. electrical fires, fireplaces, etc.)
- Desiccant dehumidifiers tend to absorb odours from the surrounding environment like cigarettes, cooking, cosmetics, new furniture etc. This smell is described as a burning or sour smell. This is released during operation as the zeolite disc is heated. This is not a sign of a fault and the smell will fade after usage.
- Do not store or use gasoline, petrol, paint, solvents or other flammable vapours and liquids in the vicinity of this dehumidifier or any other appliance. Do not use dehumidifiers where flammable gases or VOC can be released or accumulate.

ENERGY SAVING AND UNIT SAFETY PROTECTION TIPS

Do not cover or restrict the airflow from the outlet or inlet grills.

For maximum performance, the unit should be operated at least 20 cm away from walls and 50 cm from other objects within the room.

Keep the filters and grills of the appliance clean. Under normal conditions, filters and grills should only need cleaning once every three weeks (approximately). Do not use the unit without the mesh air filter as this will allow dirt to gather inside the dehumidifier, which could invalidate the warranty.

A dirty filter will restrict the airflow into the machine, which will

increase the resistance on the fan and could result in damage and might invalidate the warranty.

Since the filters remove airborne particles, more frequent cleaning may be necessary depending on the air quality. Vacuum and wash the mesh filters with hot soapy water and dry them before placing them back in the unit.

QUICK VISUAL SAFETY GUIDE ON WHERE OR WHEN NOT TO USE YOUR DEHUMIDIFIER

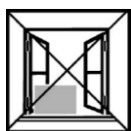

Expose to outdoor weather



Near water



If the power cable wires are frayed or cut



Where small children may be left unattended



Plug into an extension lead



Where it may be damaged by chemicals



Where the power cable may be damaged

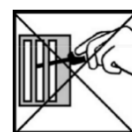

Where there is a risk of interference by foreign objects

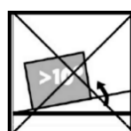

On a slope or uneven surface



This product is not for DIY repair



Where there is a risk of fire, or close to a naked flame



Where there is a risk of water falling on the unit

FEATURES:

Your DESD8LW-V2 is a top of the range desiccant dehumidifier with features not found in other units.

1. Efficient, easy to use and quiet.
2. Intelligent CPU controlled digital humidistat.
3. Control and monitor the humidity or temperature remotely using your Android or Apple phone / tablet
4. Alexa and Google home compatible: use voice commands to conveniently operate the smart dehumidifier.
5. Advanced scheduling abilities using the App.
6. Relative humidity adjustable between 40-80% with room humidity display.
Above 70%: Too humid
70% ≥ RH ≥ 60%: Above recommended humidity.
60% ≥ RH ≥ 50%: Ideal humidity level.
Below 50%: Too dry
7. Easy to use control panel with led indicators.
8. Ionizer and pre filter with PET materials.
9. Works very well at low temperatures compared with classic compressor dehumidifiers.
10. Standalone heater providing two levels of heat output with thermostatic control.
11. Heats the air passing through by between 5-10°C, making the air dry and warm reducing heating bills.
12. Tank full alarm & auto-stop function.
13. Recessed carry handle for portability

The DESD8LW-V2 desiccant dehumidifier uses desiccant technology to extract water from the environment. Desiccant dehumidifiers are ideal both at standard and low temperatures working in an ambient temperature range of between 5-35°C. The DESD8LW-V2 is light and easy to move, as it does not contain a heavy compressor. It also works intelligently as it is designed to extract unwanted humidity while saving money due to its advanced power saving logic.

It features an intelligent digital humidistat with variable humidity settings between 40-80% RH, ensuring your room is not dried too much, and power is not wasted.

INSTALLATION

Remove any water from the water tank before starting the unit. In order to save energy, do not open windows or doors while the unit is running. Place the unit on a hard / flat surface. We would advise the unit is left to run continuously for 24hrs on its first use.

TO REDUCE NOISE LEVELS:



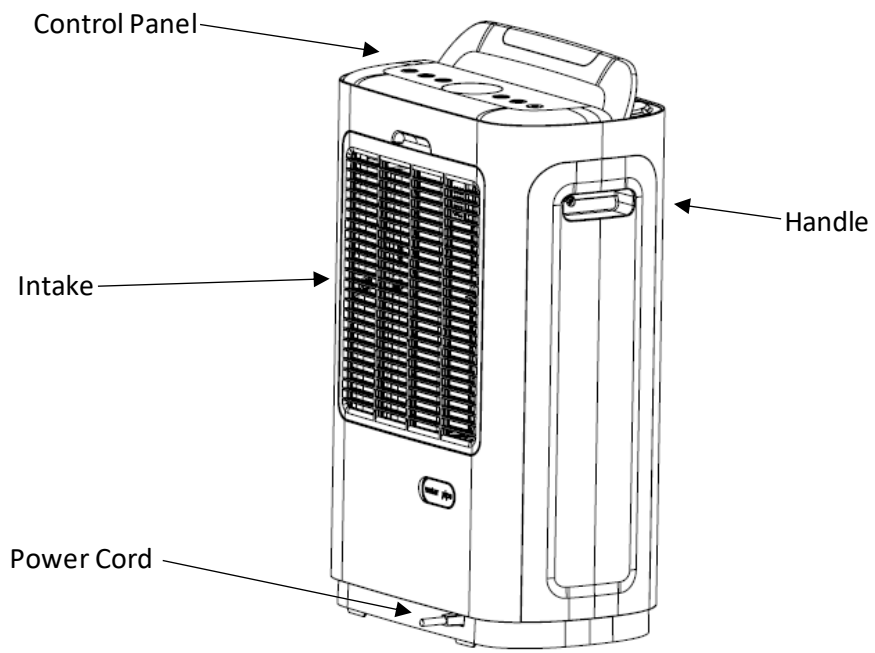
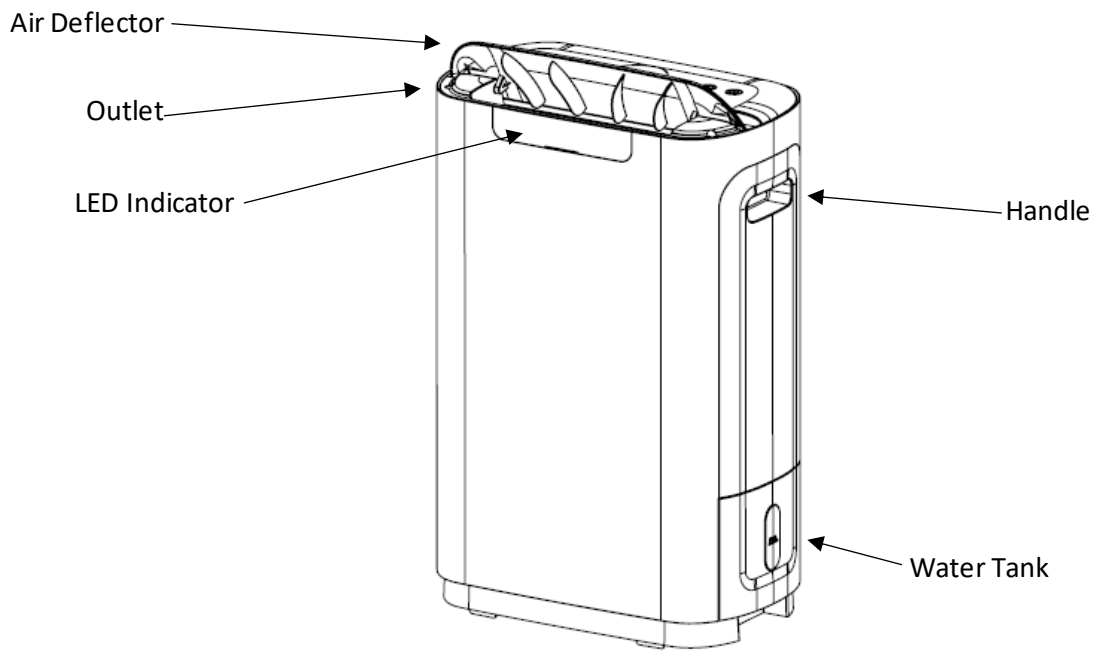

Place a piece of carpet or a rubber mat under the unit to reduce any vibrations while the unit is running. For minimum noise run the unit in sleep mode.



PARTS

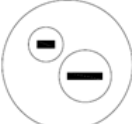

CONTROL PANEL



	<p>POWER BUTTON Turn the appliance ON/OFF.</p> <p>Please note that after turning off the unit, it will take around 10 minutes to dry the zeolite disk before operation stops.</p>
	<p>FAN SPEED This allows the user to adjust the fan speed. Pressing the fan speed button to change the fan speed from Low → Medium → High → Auto and then the cycle will repeat. When the unit is working in fan only mode. Press the button to change the fan speed from Low → Medium → High → Auto and then the cycle will repeat.</p> <p>Press and hold the button for 3 seconds to clean the P3 code. P3 code is a notice that the pre-filter needs cleaning.</p>
	<p>OSC. (OSCILLATION FUNCTION) The louvre will swing between 45 and 90 degrees.</p> <p>Press the button to turn on/off the swing function.</p> <p>WIFI Press and hold the button for 3 seconds to start pairing Wi-Fi.</p>
	<p>PLASMA IONISER BUTTON (IONISATION FUNCTION) The ioniser can refresh the air while killing viruses, dust mites, mould and airborne allergens. Press the button to turn on/off the ioniser function.</p>
	<p>TIMER BUTTON Press to set the timer. The timer will turn off the unit when the timer reaches the set time. The timer can be set from 0-8h When the timer is set, the timer led indicator will light be on.</p> <p>CHILD LOCK Press and hold the timer button for 3 seconds to turn on/off the child lock. If the unit turns off and back on. The unit will no longer be in the child lock setting.</p>

	<p>HUMIDITY Press the button to set the desired humidity. The order is shown below: CO→40%→45%→50%→55%→60%→65%→70%→75%→80%. CO is for continuous operation. In this setting the unit will continue to dehumidify no matter what the humidity is.</p>
<p>BUTTON SOUND</p>	<p>BUTTON SOUND Turn on/off the button beep. When unit is working press and hold the  &  buttons for 3 seconds to turn the button beep on/off.</p>
<p>TANK FULL</p>	<p>TANK-FULL If the water tank is full, the indicator light will flash, and the buzzer will beep 10 times. Please empty and clean the water tank to continue operation. The light will also illuminate if the tank is incorrectly fitted. Once refitted the unit will operate.</p>
<p>OPERATION</p>	<p>OPERATION The operation light will illuminate when the unit is running to extract moisture from the air. Please note this may not light up immediately when the unit is started.</p>

HUMIDITY LEVEL & TIMER 2 DIGIT DISPLAY

The led indicator performs the following functions:

WHEN THE UNIT IS PLUGGED IN: It will indicate the humidity level of the room.

WHEN ONE OF THE HUMIDITY SETTING BUTTONS ARE PRESSED: It will indicate the desired humidity, before reverting to showing the current humidity after a few seconds.

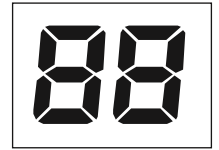

WHEN THE TIMER BUTTON IS PRESSED: It will indicate how many hours the timer function will operate, before reverting to showing the current humidity after a few seconds

CLEAN THE GRILLE AND CASE

Use water and a mild detergent to clean the washable mesh filters. Do not use bleach or abrasives. Do not splash water directly onto the main unit. Doing so may cause electric shock and can cause the insulation to deteriorate, or the unit to rust. The air intake and outlet grilles get soiled easily, so use a vacuum attachment or soft brush to clean. Wipe the dehumidifier body with a soft damp cloth or kitchen towel.

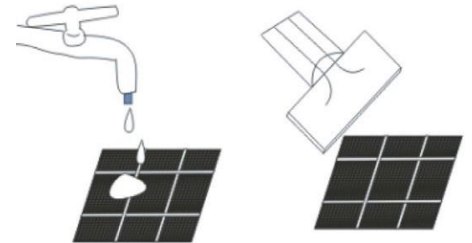

HEPA FILTER (OPTIONAL):

If using a HEPA filter, according to the time and frequency of use, it is generally recommended to replace the HEPA filter after about 3 months. The HEPA filter cannot be washed.

HEPA filters can be sourced from the supplier using the reference : **FIL-DESD8LW-V2HEPA**

QUICK REFERENCE GUIDE



POWER BUTTON: Press the power button to turn the dehumidifier on and off.



SWING CONTROL BUTTON: Press once to make the louvres swing and press again to lock at 45 degrees-90 degrees. Do not operate the unit if the self-opening louvers do not open when the unit is powered on.



TIMER BUTTON: Press the timer button to adjust the duration of the timer (1-8 hrs, start / stop timer).

IN POWER ON MODE: The number displayed will represent the number of hours the unit will run for before turning off.

WHEN THE APPLIANCE IS RUNNING

1. When the room humidity level is lower than the target humidity, the heater will stop and the fan will continue to run at low speed for air circulation.
2. When the room humidity is higher than the desired level, then the heater will reactivate to work for 4 hours and stop 30 minutes as a circulation to extract the moisture.

Please Note: If a permanent drainage pipe is fitted, the unit will not stop operation. Setting the desired humidity to around 40% is good for a drying boost, on the unit's initial run, or in emergencies. It is not recommended to use it with these settings for normal operation in a domestic or office environment over a long period of time, as the air may become uncomfortably dry.

For allowing more moisture in the air, press the humidity button to set to a higher percentage value (e.g. 60-70%).

CO-45% RH – Recommended for boosting drying and emergencies.

50-55% RH - Recommended setting, great for domestic operation and dry storage.

60% RH - Great for personal comfort and applications where 50% RH is considered too dry.

70% RH - Ideal for unoccupied properties or where an economical run is needed without the need to go drier than 70% RH

OTHER FEATURES AND INDICATORS

TANK FULL LIGHT

The light will illuminate and the unit will beep when the tank is ready to be emptied, or if the water tank is incorrectly inserted. The water level control will shut off the dehumidifier until the tank has been emptied and replaced in its proper position.

AUTO-RESTART

When turning off the unit in standby mode, the unit will remember the last setting when the unit is turned on again.

If power failure occurs, the unit can restart automatically and the memory function will not work.

If set to “child lock” and “timer”, the unit will shut off when the timer is done, but the memory function will not work on child lock and timer when the unit is turned on again.

LIGHTWEIGHT PORTABLE DESIGN ON CASTORS

The dehumidifier is built to be compact and lightweight. Your dehumidifier is an advanced micro-CPU controlled device capable of self-diagnostics. The LCD display may also show error and protection codes.

POSITIONING THE DEHUMIDIFIER

A badly positioned dehumidifier will have little effect. In positioning the dehumidifier please ensure circulation of the air is not restricted around the unit. At least 20 cm space should be allowed around the unit.

This dehumidifier is designed for indoor residential / small office applications only and any commercial or industrial use will invalidate the warranty.

Use the dehumidifier in an enclosed area for maximum efficiency. Close all external doors and windows to create an effective operating environment. Do not use outdoors.

Your electriQ dehumidifier will begin to protect your space from the harmful effects of excessive moisture as soon as it is turned on. Excess moisture is dispersed throughout your home. For this reason, the dehumidifier should be positioned in a central and clear location so that it can draw this moist air towards it. A warm hallway or landing is an ideal position for your dehumidifier. If possible, leave interior doors ajar to allow air circulation between rooms.

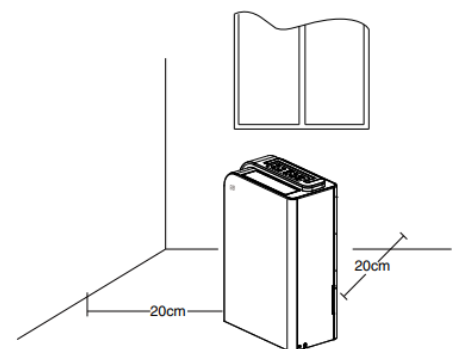

Alternatively, if you have a serious problem in one area you can begin by positioning the dehumidifier in that area and moving it to a more central location at a later date. Please note the unit should not be placed directly against a radiator or other heat source. When positioning your electriQ dehumidifier, ensure that it is placed clear of any obstacle that may limit the air movement, and ensure it is placed on a dry flat surface.

WATER DRAINAGE

When the water tank is full, the unit will stop operating. When this happens, the TANK FULL light will show on the control panel, and the unit will bleep.

Note: Only empty the water tank when it is full or before moving or storing the unit. There are two ways to dispense collected water.

USE THE INTERNAL WATER TANK

When the tank is full, the unit will stop running, and the TANK FULL indicator light will display. Grip the tank securely and carefully pull out. Empty the water tank and reinsert it into the dehumidifier. The tank must be in place and securely seated for the dehumidifier to operate again. The dehumidifier will re-start when the tank is restored to its correct position.

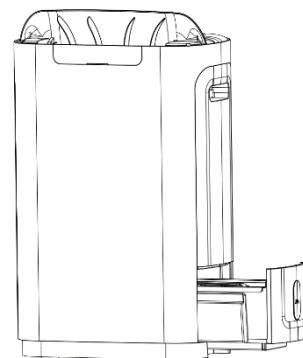

NOTES:

- Do not remove the water tank immediately after the unit stops. Please wait a while to avoid the water dripping into the unit and causing damage.
- Only empty the water tank when it is full or before moving or storing the unit.
- Do not rest the tank on the floor because the bottom of the tank could be uneven and the tank may fall, causing water to spill.
- When you remove the tank, do not touch sensors or any parts which are situated behind the tank. Doing so may damage the product. Be sure to push the tank gently all the way into the unit. Banging the tank against anything or failing to push it securely into place may prevent the unit from operating.
- Do not remove or damage the float switch in the water tank, otherwise the machine will stop working.
- Please make sure the water tank cover is put back into place correctly before the water tank is reinserted.
- If the water tank is inserted incorrectly, the full tank indicator will illuminate. Remove the water tank and reinsert to turn the indicator off and resume normal use.
- At all times, avoid water entering the unit. It may cause an electrical hazard and damage the unit.

SET UP CONTINUOUS DRAINAGE

The dehumidifier has a continuous drain hole that can be connected to a plastic pipe with a length of 2m and an inner diameter of $\Phi 15 \times \Phi 18$ mm (Not Supplied). Water can be plumbed in or drained into a sink, a larger receptacle or through the wall into an outside drain. Please follow the steps below to set your unit up for continuous drainage.

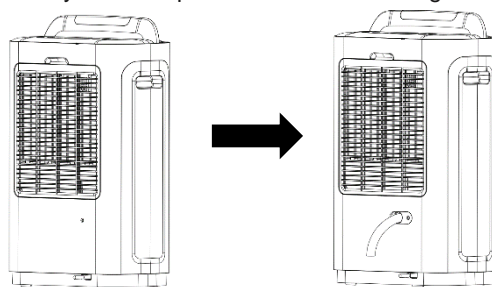

1. Cut off the cover for the continuous drain on the back of the unit.
2. Pull out the water tank and connect a water tube with an inner diameter of 15mm to the drain connector, and ensure the connection is tight
3. Replace the water tank into position within the unit.

This unit uses gravity to dispose of the water collected and as such the drain should be lower than the dehumidifier water outlet. Be sure to run the water pipe downward and let the water flow out smoothly. Do not kink or bend the pipe.

NOTE: When the continuous drain feature is not being used, remove the pipe installation, to start the water collecting in the water tank. The permanent drain can be used in conjunction with a water pump (e.g. when draining from a cellar) to lift the water upwards.

SETTING UP THE WIFI APP

BEFORE YOU START

- Ensure your router provides a standard 2.4GHz connection.
- If your router is dual-band ensure that both networks have different network names (SSID). The provider of your router / Internet service provider will be able to provide advice specific to your router.
- Place the dehumidifier as close as possible to the router during setup.
- Once the app has been installed on your phone, turn off the data connection, and ensure your phone is connected to your router via WIFI.

DOWNLOAD THE APP TO YOUR PHONE

Download the "TUYA SMART" app, from your chosen app store, using the QR codes below, or by searching for the app in your chosen store.



Android



IOS

CONNECTION METHODS AVAILABLE FOR SETUP

The smart device has two different setup modes, CF (Quick Connection) and AP (Access Point). The quick connection is a quick and simple way to set the unit up. AP connection uses a direct local WIFI connection between your phone and the dehumidifier to upload the network details.

Before starting the setup, please ensure that your dehumidifier is in the correct standby mode for the connection type you are attempting, the display your dehumidifier will indicate this.

To connect to the WIFI, press and hold the SWING button when the unit is in standby mode for approximately 3 seconds

CHANGING BETWEEN CONNECTION MODES / WIFI RESET

To change the unit between the two connection types, hold the SWING button for 3 seconds. The connection mode is signified by the frequency of the flashing Smart light. This will also remove any previous WIFI configuration.

Connection Type	Frequency of Flashes
CF (Quick Connection)	Flashes twice per second
AP (Access Point)	Flashes once per second

REGISTER THE APP

1. Press on the register button at the bottom of the screen.

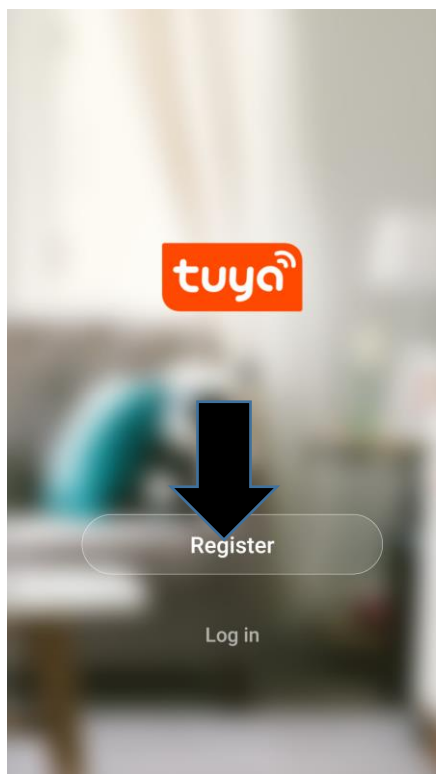

2. Read the Privacy policy and press the Agree Button.

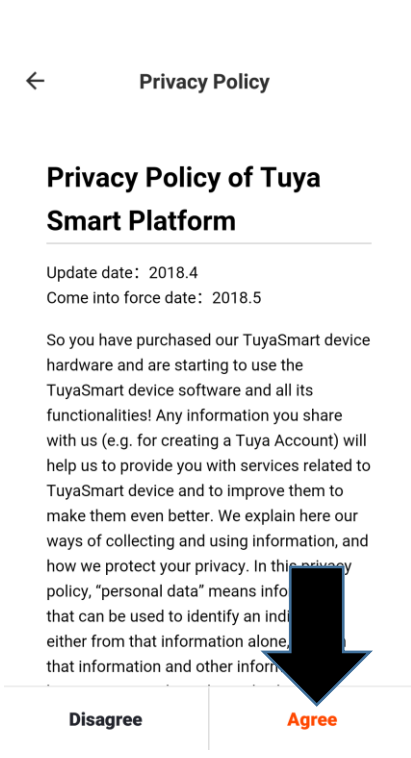

3. Enter your email address or phone number and press continue to register.

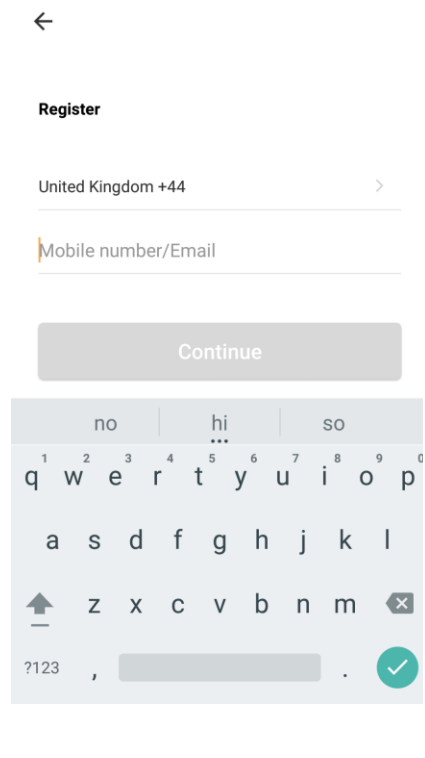

4. A verification code will be sent by the method selected in step 3. Enter the code into the app.

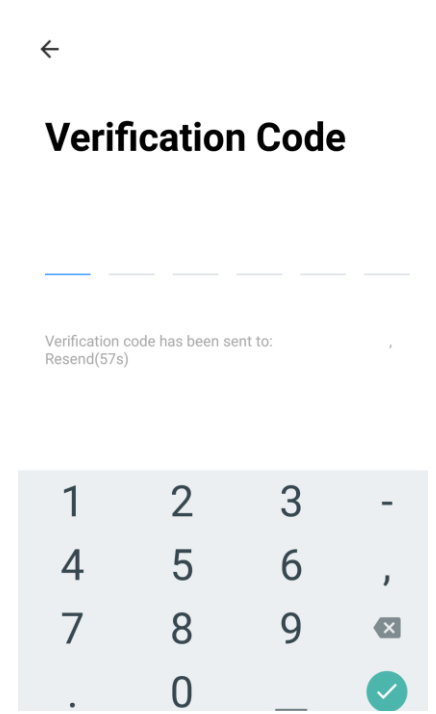

5. Type in the password you would like to create. This needs to be 6-20 characters, with letters and numbers.

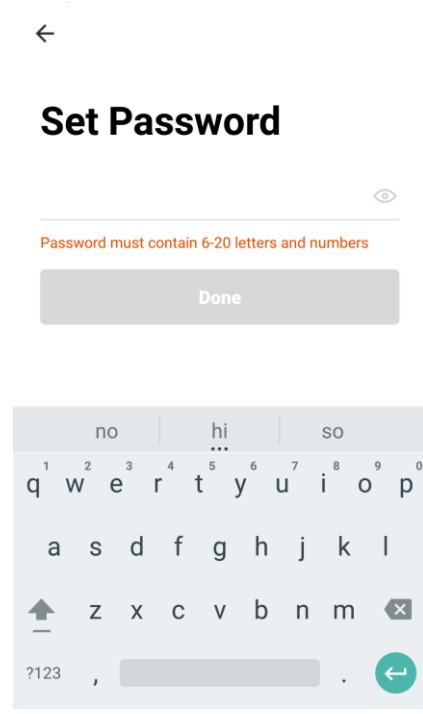

2. The app is now registered. It will automatically log you in following registration.

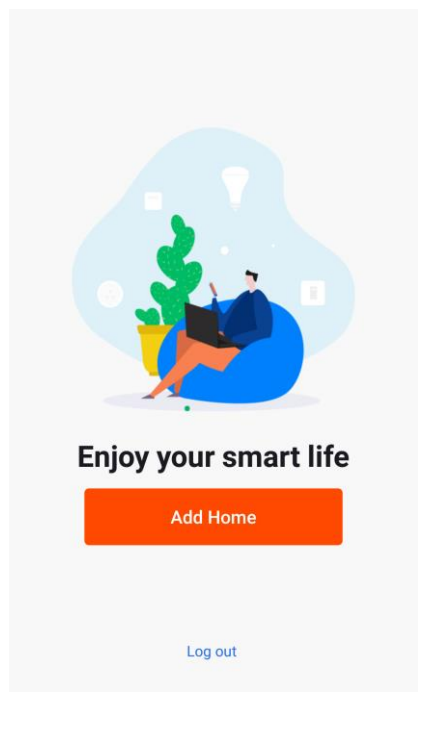

SETTING UP YOUR HOME WITHIN THE APP

TUYA is designed so it can work with a large number of compatible smart devices within your home. It can also be set up to work with multiple devices within different houses. As such, during the setup process the app requires that different areas are created and named to allow easy management of all your devices. When devices are then added, they are assigned to one of the rooms you have created.

CREATING ROOMS

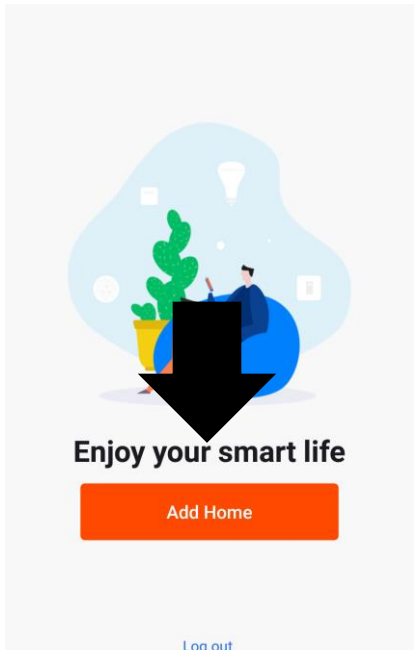
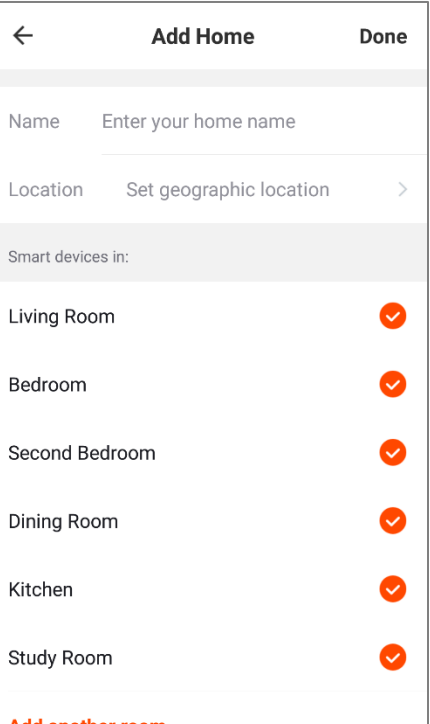
<p>1. Press on the ADD HOME button.</p> 	<p>2. Type in a name for your home, 3. Press on the location button to select the location of your home. (See SETTING YOUR LOCATION below) 4. New rooms can be added by pressing the ADD ANOTHER ROOM option at the bottom. (See ADD ANOTHER ROOM below) 5. Untick any rooms that are not required on the app. 6. Press DONE in the top right corner.</p>	
--	---	--

SETTING YOUR LOCATION

Use your finger to move the orange HOME symbol.

When the symbol is in the approximate location of your home, press the confirm button in the top right corner.

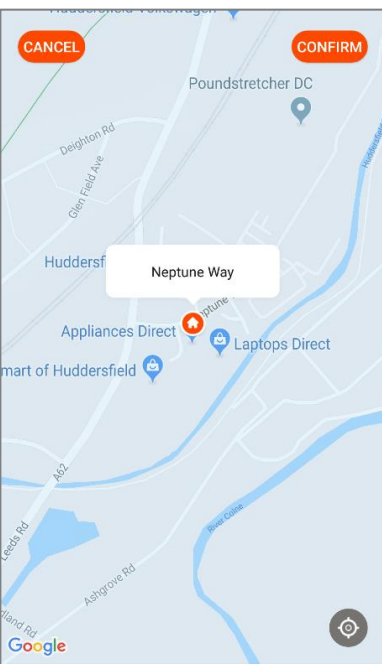

ADD ANOTHER ROOM

Type in the name of the room, and press Done in the top right corner

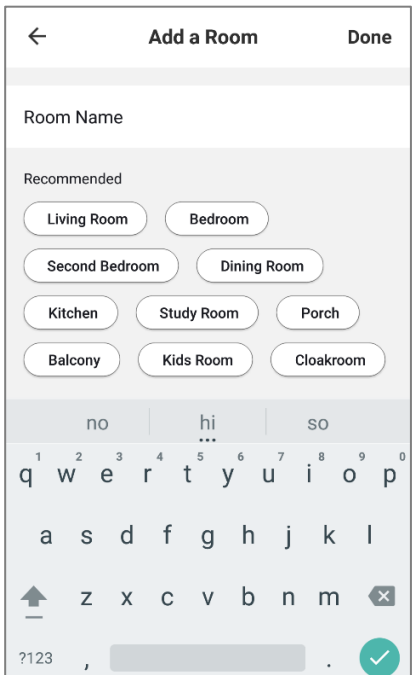

CONNECTING USING QUICK CONNECTION

Before initiating the connection, make sure the unit is in standby mode, with the WIFI light flashing twice per second. If not, follow the instructions for changing the connection mode. Ensure your phone is connected to the WIFI network. (We advise turning mobile data off during setup)

1. Open app and press “+” to add device, or use the add device button

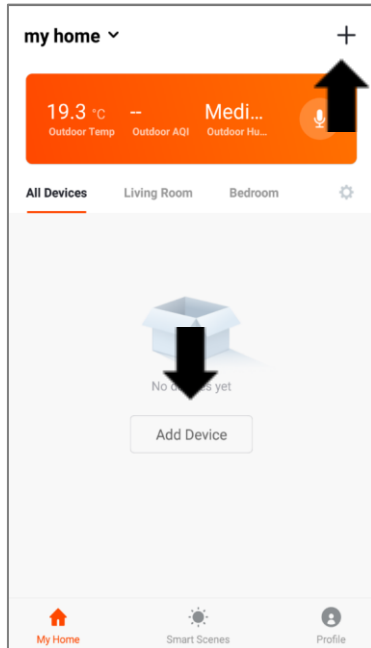

2. Select the type of device as “Dehumidifier” in the Small Home Appliance tab.

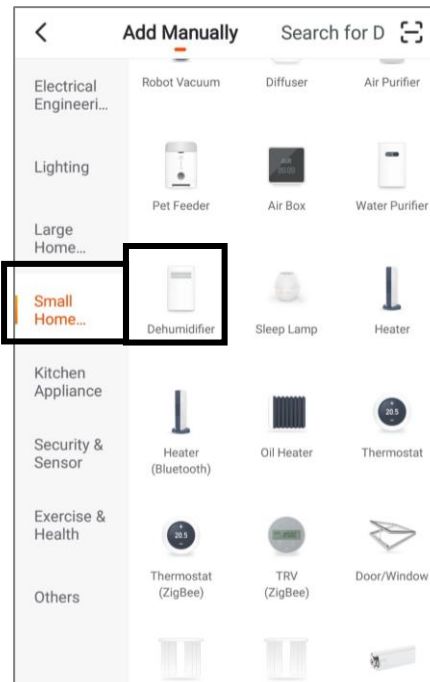

3. Ensure the WIFI light on the dehumidifier is flashing twice per second then press on the orange button at the bottom of the screen to confirm.

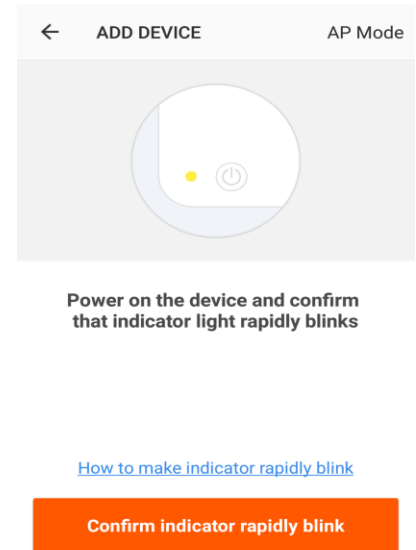

4. Enter your WIFI password and press confirm.

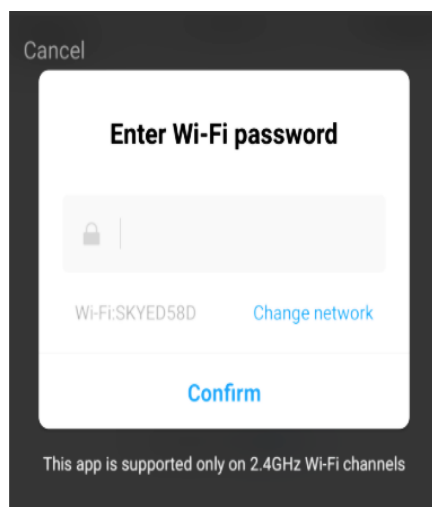

5. This will then transfer the settings to the dehumidifier. Wait for this to complete. If this fails, retry. If still unsuccessful please review the troubleshooting section for further help.

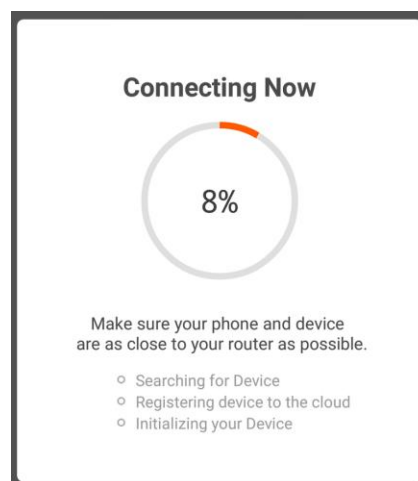

CONNECTING USING AP MODE (ALTERNATIVE METHOD)

Before initiating the connection, make sure the unit is in standby mode, with the WIFI light flashing once per second. If not, follow the instructions for changing the connection type. Ensure your phone is connected to the WIFI network. (We advise turning mobile data off during setup)

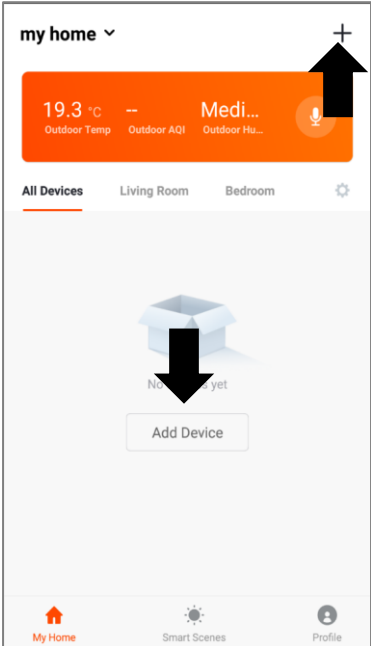
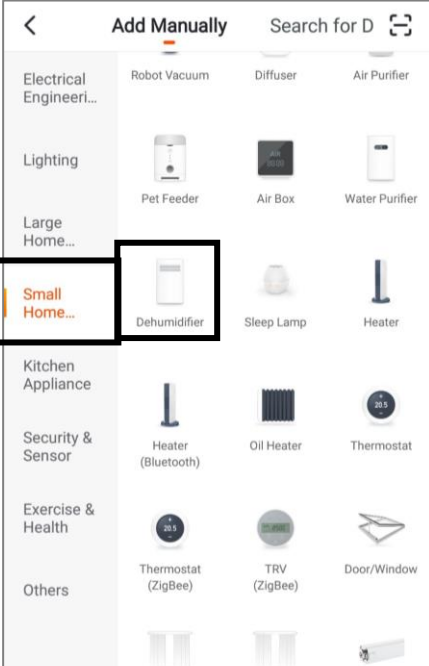
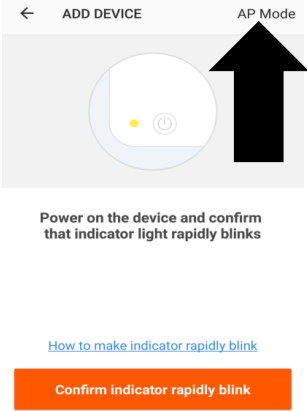
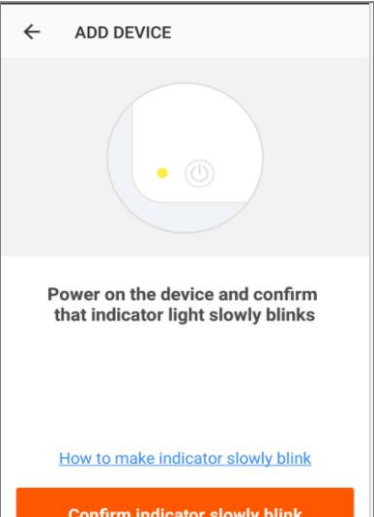
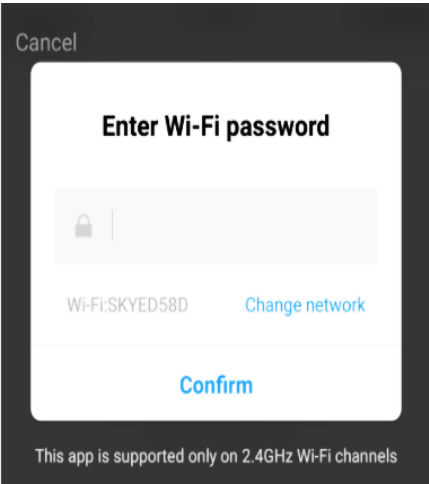
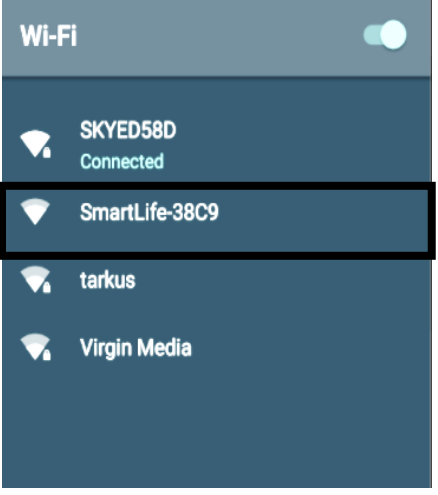
<p>1. Open app and press “+” to add device, or use the add device button</p> 	<p>2. Select the type of device as “Dehumidifier”</p> 	<p>3. Press on the AP mode button in the top right of the screen.</p> 
<p>4. Ensure the WIFI light on the dehumidifier is slowly flashing (once per second), then press on the orange button at the bottom of the screen to confirm</p> 	<p>5. Enter your WIFI password and press confirm.</p> 	<p>6. Go to network settings in your phone and connect to the “SmartLife xxx” connection. There is no password to enter. Then return back to the app to complete setup.</p> 
<p>This will then transfer the settings to the dehumidifier. Once the connection process has completed, go back to the network settings on your phone to ensure your phone has reconnected to your WIFI router.</p>		

CONTROLLING YOUR DEVICE THROUGH THE APP

THE HOME SCREEN

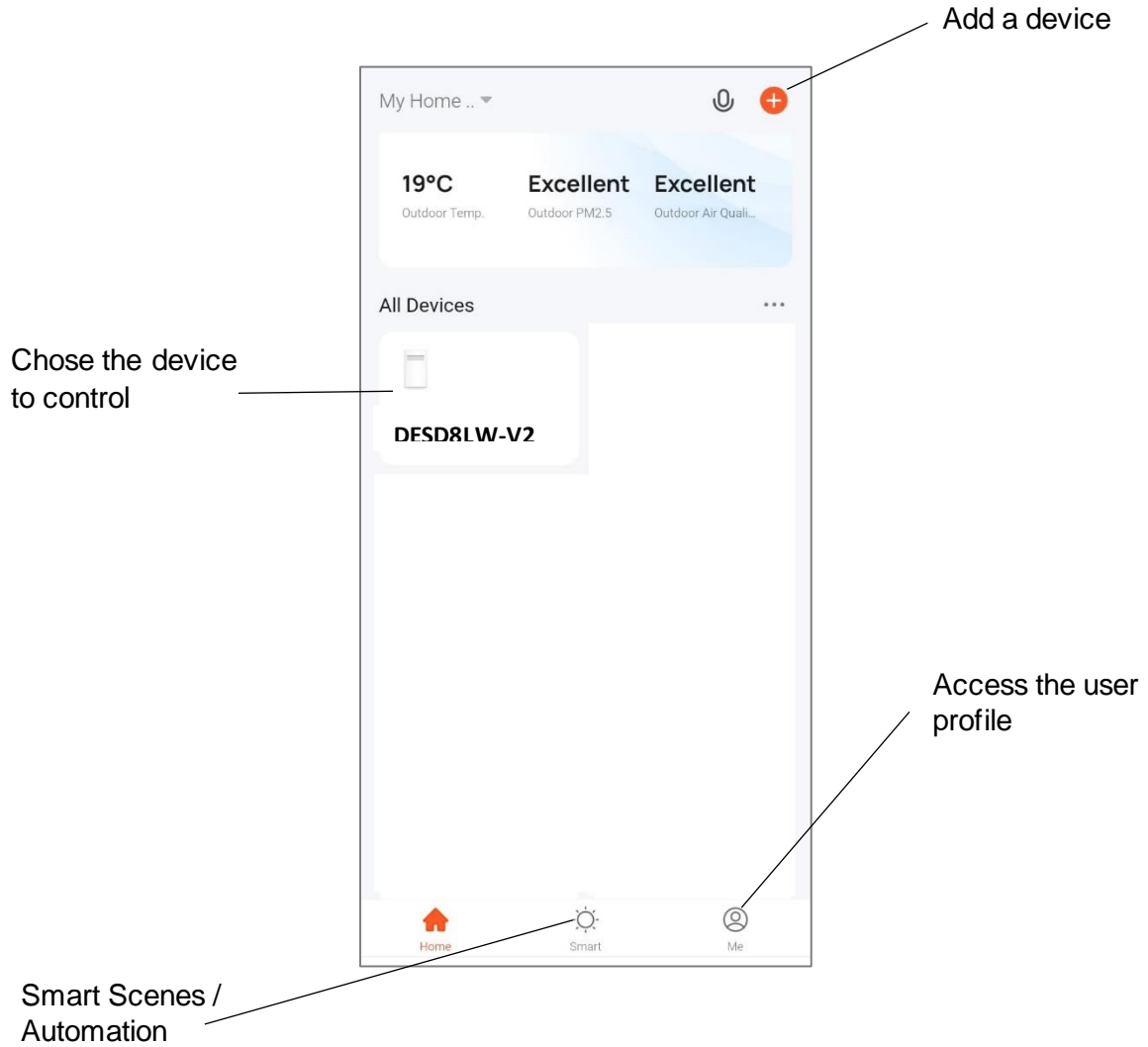

DEVICE SCREEN

The device screen is the main control screen for the dehumidifier, providing access to the controls to amend the functions of the dehumidifier.

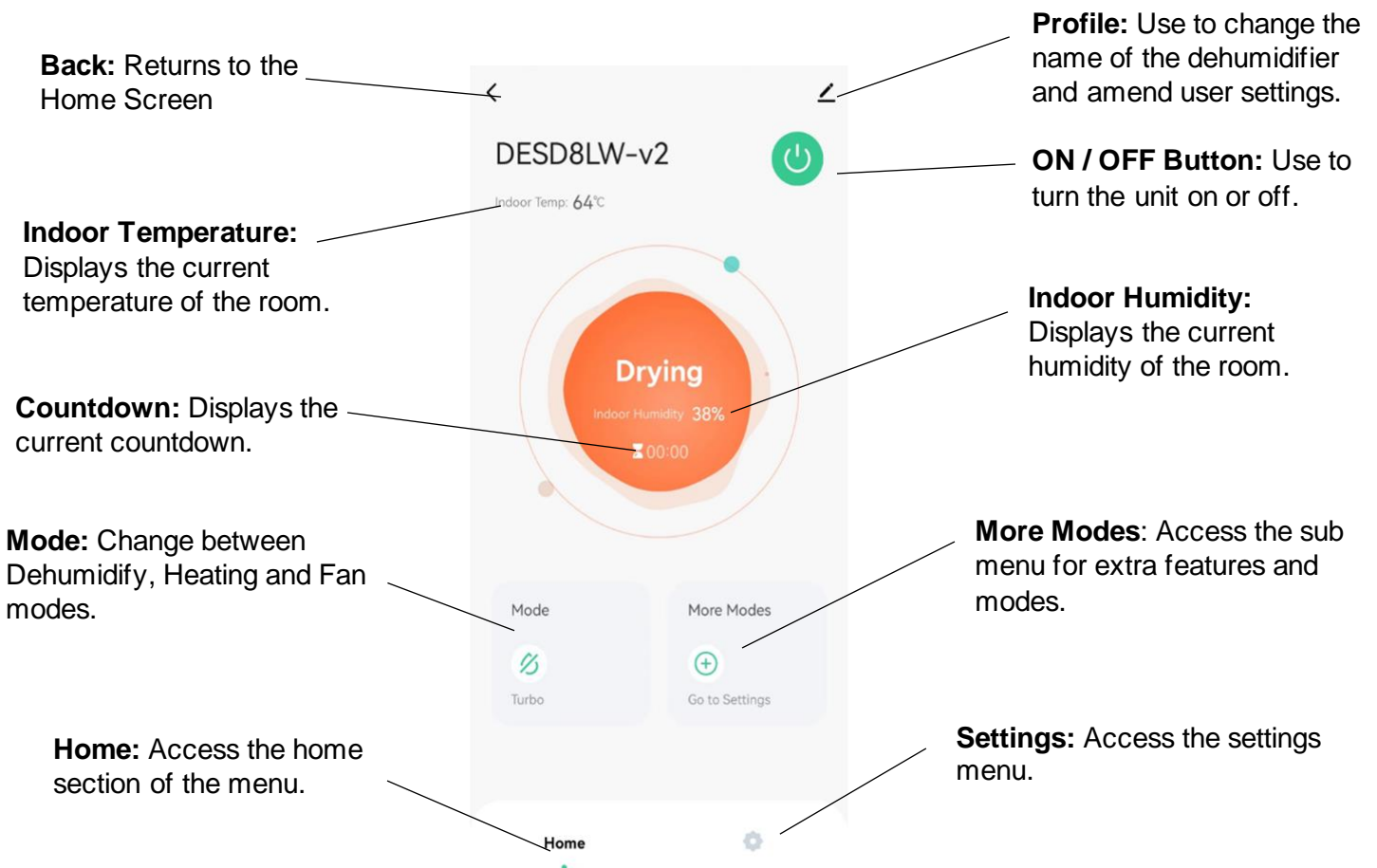

MORE MODES

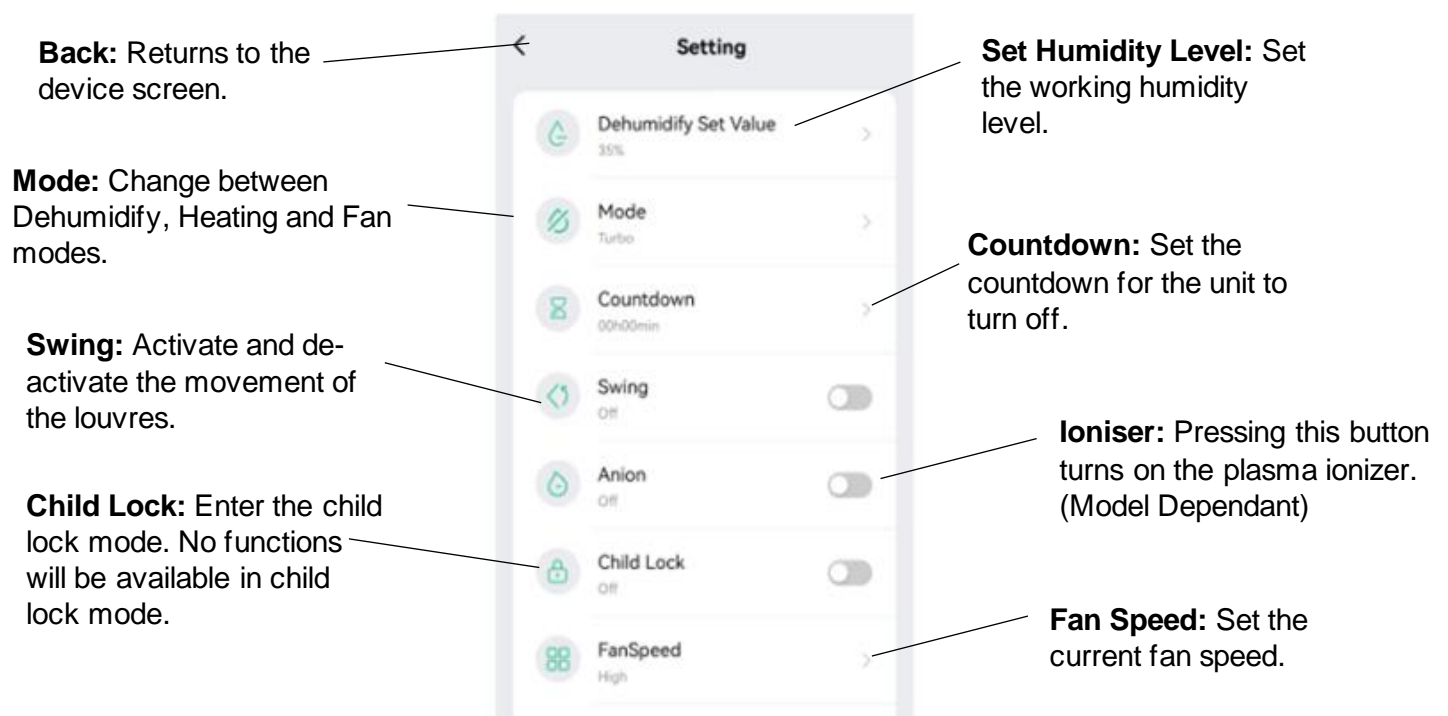

SMART SCENES

Smart Scenes is a powerful tool providing the option to customise the operation of the dehumidifier based both on conditions within the room and outside influences. This gives the user the option of specifying much more intelligent actions. These are split into two categories Scene and Automation.

SCENE

Scene allows for a one-touch button to be added to the Home screen. The button can be used to change a number of settings in one go and can change all the settings within the unit. A number of scenes can easily be set up, allowing the user to easily change between a number of preset configurations.

Below is an example of how to set up a scene:

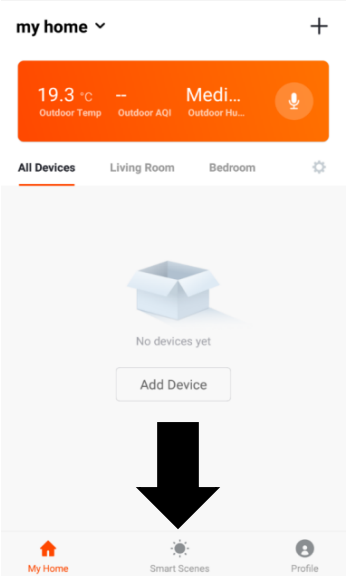
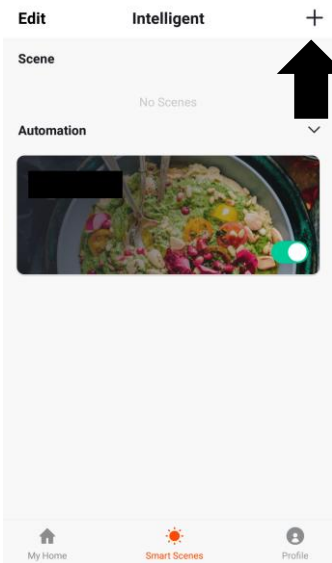
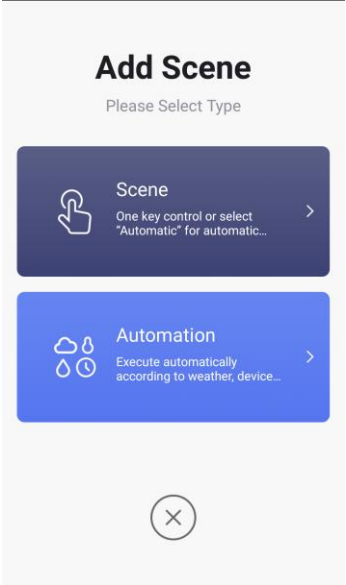
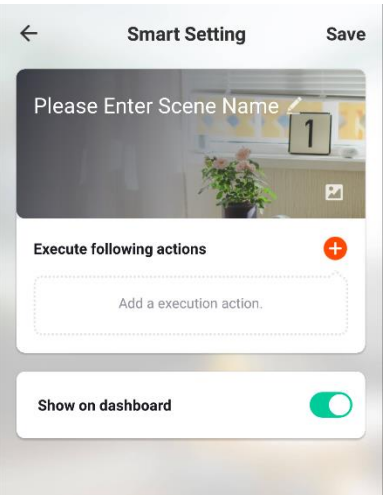
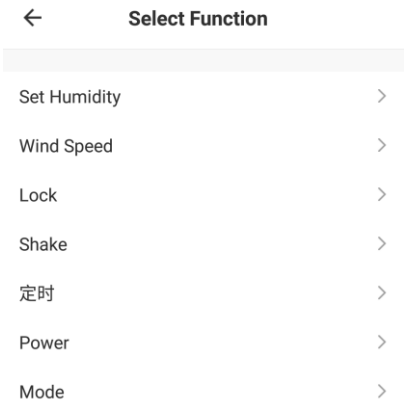
<p>1. Press on the Smart Scene tab at the bottom of the Home screen</p> 	<p>2. Press on the Plus in the top right corner to add a smart scene.</p> 	<p>3. Select Scene to create a new Scene</p> 
	<p>4. Press the Pen next to "Please Enter Scene Name" to input the name for your Scene</p> <p>Show on Dashboard: Leave this on if you require the scene to be displayed as a button on the Home Screen</p> <p>Press the Red Plus to add the action required. Then select the dehumidifier from the list of devices.</p>	<p>5. Chose the function, set the value for the function, and then press the back button in the top right corner, to return to the previous screen.</p> 
<p>6. Once all the functions required have been added, press the Save button in the top right corner to finalise and save your new Scene</p>		

AUTOMATION

Automation allows an automatic action to be set up for the device. This can be triggered by the Time, indoor temperature, humidity of the room, weather conditions, and a range of other influences.

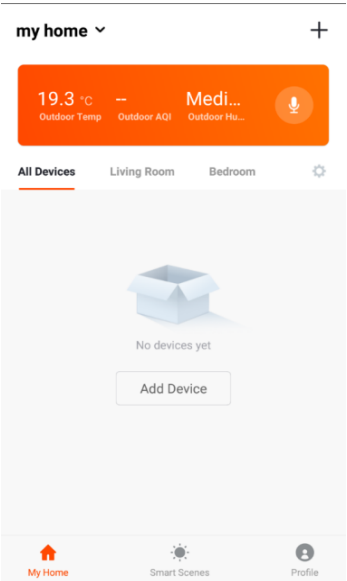
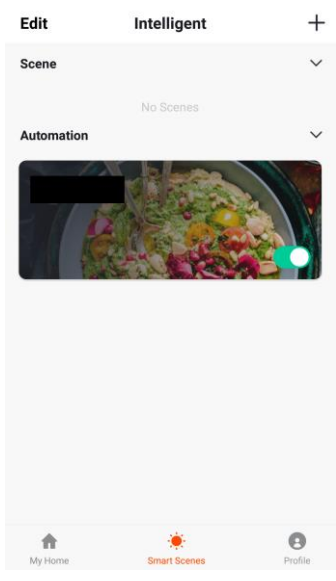
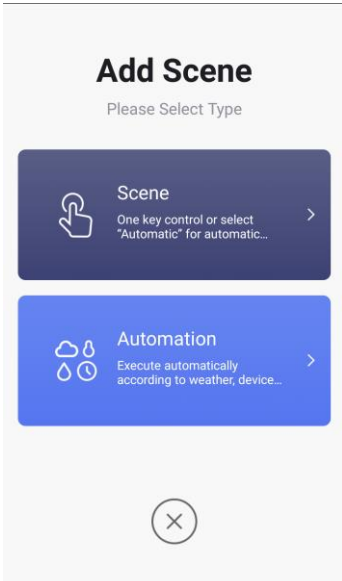
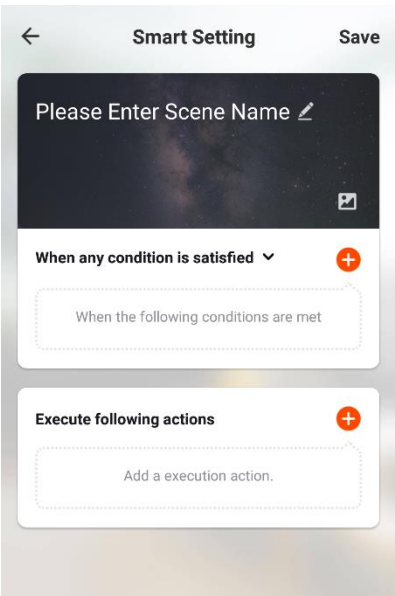
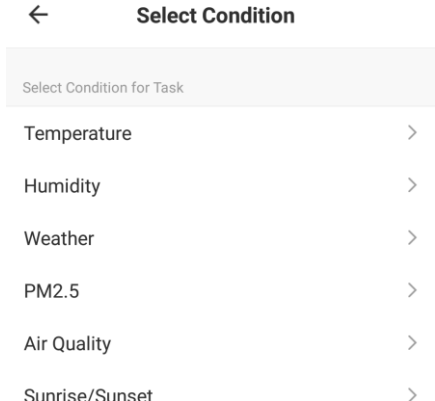
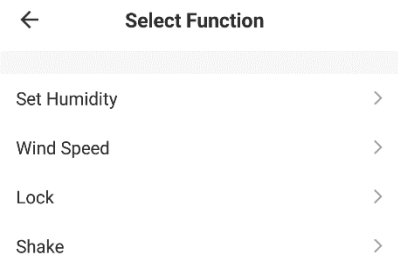
<p>1. Press on the Smart Scene tab at the bottom of the Home screen</p> 	<p>2. Press on the Plus in the top right corner to add a smart scene.</p> 	<p>3. Select Automation to create a new Automation Scene</p> 
<p>4. Setup is very similar to the scene setup on the previous page, and includes an extra section for specifying a trigger for the scene to start.</p>  <p>Press the Pen next to “Please Enter Scene Name” to input the name for your Scene</p> <p>Press the Red Plus next to “When any condition is satisfied” to add the trigger</p> <p>Press the Red Plus next to “Execute following actions” to add the action required. Then select the dehumidifier from the list of devices.</p>	<p>5. Select the condition when the automation should start. A number of triggers can be combined.</p> 	
<p>6. Chose the function, set the value for the function, and then press the back button in the top right corner, to return to the previous screen.</p> 	<p>7. Once all the functions required have been added, press the Save button in the top right corner to finalise and save your new scene.</p> <p>The automation is now set up, it can be turned on and off using the toggle on the image shown on step 2.</p>	

DEVICE DETAILS SCREEN

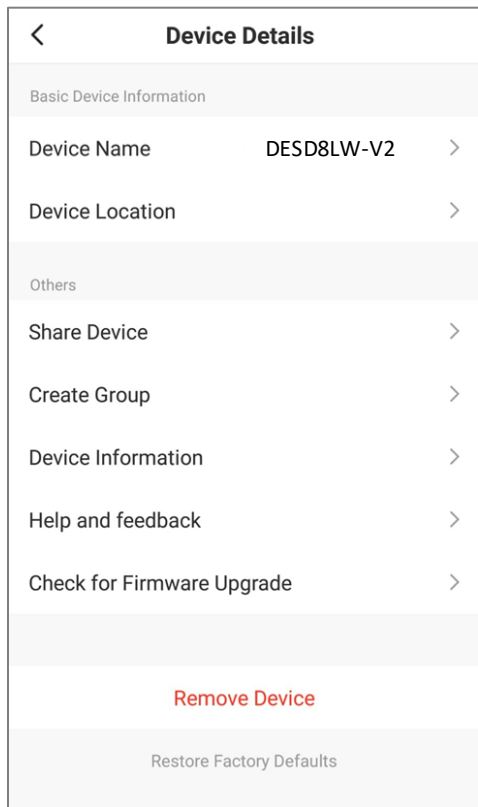

The device details screen gives you the option to edit the details for the device, and use some of its additional features. The device details screen can be accessed from the device screen by pressing on the symbol in the top right hand corner.

CHANGING THE NAME OF YOUR DEVICE

The top option within this allows you to change the name of the device to something relevant to the use of the product, such as “Living Room Dehumidifier”. Within the menu, you also have the option of setting up a pattern lock or change your password.

DEVICE SHARING

This allows you to share access to the controls of your dehumidifier with friends and family.

PROFILE TAB

The Profile tab allows you to make changes to the app, such as setting up a username and editing or adding rooms.

Within the Profile tab, you are also able to change settings related to the app itself.

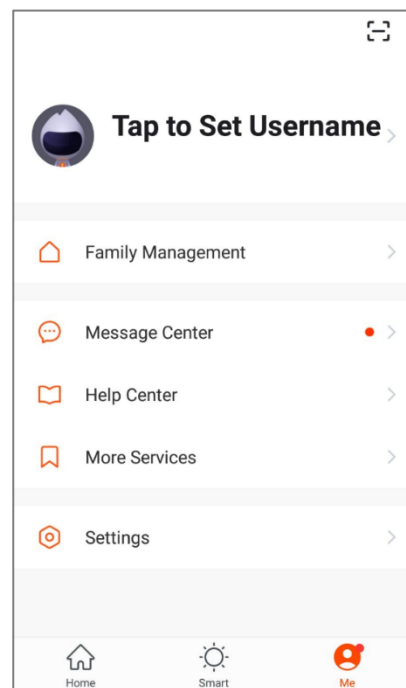

CONNECTION TROUBLESHOOTING

1. Check whether the device is powered on and is in the correct standby mode, if not please refer to the CHANGING BETWEEN CONNECTION MODES section on page 12.
2. Ensure the WIFI password has been entered into the app correctly (Case sensitive)
3. Check that the phone is connected to the WIFI you are connecting the device to.
4. Ensure the network you are connecting it to is 2.4Ghz (5Ghz WIFI networks are not supported), and that there is a strong WIFI signal to the item.
5. If your router is dual band, ensure that the 2.4ghz network has a different network name (SSID). Further advice on changing router settings will be available from your Internet service provider / Router manufacturer.
6. Check the settings on the router. Encryption should be WPA2-PSK and authorisation type should be set to AES
7. Try using the alternative connection method. i.e. If connection is failing when attempting to connect through CF mode, try AP mode.

CARE AND MAINTENANCE

Always shut off the unit and unplug it from the mains before cleaning or performing any maintenance. When it is not in use for long periods, it is advisable to remove the plug from the power socket. Do not use chemical solvents (such as benzene, alcohol or gasoline) as they may cause irreversible damage to the unit.

FILTER CLEANING

The Air-inlet may gather dust easily, clean it often with a soft, damp cloth. If the filter is covered by dust, the airflow and the performance of the unit will be affected. It may even cause damage to the unit. We recommend that you regularly clean the filters. The dehumidifier must be disconnected from the socket before maintenance, and the filters must be allowed to fully dry before use.

1. Remove the filters from the unit, and tap the dust away.
2. Clean the mesh filter with a vacuum cleaner or a soft brush.
3. If dirt and grease have accumulated, wash the mesh filter in hot soapy water.
4. Replace the filters in position.

NOTE: Never use the unit without the antibacterial mesh dust filter.

HEPA FILTER (OPTIONAL):

If using a HEPA filter, according to the time and frequency of use, it is generally recommended to replace the HEPA filter after about 3 months. The HEPA filter cannot be washed.

CLEAN THE WATER TANK

Every few weeks, clean the tank to prevent the growth of mould, mildew and bacteria. Partially fill the tank with clean water and add a little mild detergent. Swish it around before emptying the tank and rinsing.

NOTE: Do not use a dishwasher to clean the tank. After cleaning and drying the tank must be reinserted securely into the dehumidifier in order to restart operation.

END OF SEASON MAINTENANCE

1. Empty and clean the water tank.
2. Clean the unit and the filters as per the cleaning procedure above.
3. Coil the power cord on the special cord storage rest at the back of the unit.
4. Cover the unit and keep it in a dry place.

POWER CORD MAINTENANCE AND REPLACEMENT

If the power cord is damaged, it could cause a short circuit or become a fire risk. Please avoid pulling the cord, twisting or pressing it and keep it away from pets. If the power cord is damaged, power the unit off and unplug it immediately. Contact an electrician or service centre for repairs; do not attempt to repair the unit yourself.

TROUBLESHOOTING

Problem	Possible Cause	Solution
The unit does not work	Power is abnormal	Contact an electrician to perform a repair.
	Water tank displaced or full	Check water tank placement or empty water tank
	Room temperature is too high, or air-outlet is covered	Lower room temperature, clear air outlet
Poor performance	Filter is dirty	Clean the filter
	Door & windows are open	Close door & windows
	Air-inlet or out-let is blocked.	Clean air-inlet & air-outlet
Too Noisy	Unit is not placed on even surface.	Place the machine on the flat surface. Add carpet or rubber mat underneath
	Filter is blocked	Clean the filter
The device does not dehumidify	The relative humidity in the room where the dehumidifier is operating is too low.	The dehumidifier dries down to the target relative humidity set and will then go into standby if the desired humidity has been reached.
The dehumidifier works, but relative humidity is still high	The place is too large. This dehumidifier can dry up to about a small five-bedroom house.	We recommend using a dehumidifier with a greater capacity. Call customer service line for advice.
	There are too many sources of moisture. Bathing, washing, drying clothes and cooking all put moisture into the air.	We recommend using a dehumidifier with a greater capacity.
	Paraffin or Calor gas heating can add too much moisture into the air	Consider using alternative heat sources
The windows were clear, and now condensation has returned.	The outside air temperature has dropped significantly, and the windows are colder.	Set the dehumidifier to 40%RH and run for longer
I cannot remove the condensation from my windows, even in "Continuous" or "Laundry" mode	The surface temperature of the windows is too low for a dehumidifier to prevent condensation. Common with single glazed windows or poorly insulated houses when the outside air temperature drops below 0°C	Keep running the dehumidifier on "Laundry" 24 hours a day and if the air temperature outside increases the condensation on windows may clear
The dehumidifier is blowing out warm air	The dried air is passed over a heating element before it is blown into the room as part of the dehumidification process	This is normal and helpful, especially in the cold weather; a dehumidifier is not an air cooler.
Knocking noise coming from the dehumidifier	The motor wheel is low on lubrication or dirt may have entered the motor ball bearings	Run the dehumidifier in Laundry mode for two days to increase the lubrication, if the fault persists then call the service centre

Water not draining down the hose	The hose is fitted for continuous drainage, but the water still goes into the tank	Negative air pressure in the room is pulling the water back into the dehumidifier overflow. Insert a 3 mm hole into the top of the tube 25 mm down from the spout. This will introduce air into the tube and balance out the air pressure.
		Dirt is gathered in the internal tray. May need servicing.
		If the fault persists then call the service centre
Dehumidifier leaks water onto the floor	Usually means that the dehumidifier is not on a level surface or that the filter has not been cleaned often enough and dirt has fallen into the internal tray dehumidifier.	Check that the water bucket is not cracked by filling it with water and placing it on kitchen paper on the kitchen side.
		Check if filters are clean
		If the fault persists then call the service centre
Machine not switching off the heater when desired humidity is reached	Temperature and relative humidity sensor that reads the room reading is unable to read the correct readings	Clean the filter and blow the air sensor with a hover or hairdryer on the COLD setting to clear the sensor of dirt
		Unplug the dehumidifier for 10 minutes to reset PCB and then turn back on.
		If the fault persists then call the service centre
On pressing power off fan still works for around minutes and switches off	Unit is drying/cooling internally before going in off mode	Normal operation. DO NOT remove power until this has finished.

Note: when the fault cannot be solved by the solutions above, please contact the service centre for help, do not attempt repairs.

Error code	Reason
C1	NTC1 is open cut or short cut
C2	NTC 2 is open cut or short cut
C3	NTC1 & NTC 2 are open cut or short cut
C4	Sync motor is failure
P3	Pre-filter clean notice
88	Temperature and humidity sensor failure

FREQUENTLY ASKED QUESTIONS

WHY DOESN'T THE UNIT WORK /OR STOPS SUDDENLY?

The water tank may be full or displaced. Empty the tank and carefully replace in the unit to rectify.

WHY DOES IT REQUIRE EMPTYING VERY REGULARLY?

When you first use your dehumidifier, it will work harder to reduce the room humidity down to 50%RH (SMART mode or the desired humidity set in dehumidifier mode). This is the time when it will produce the most water and as such will require emptying most frequently (even 2-3 times /day). As the room becomes dryer, the dehumidifier will collect less water and it will take longer to fill the tank, this is perfectly normal. When the target relative humidity has been reached the dehumidifier will stop collecting water and will operate for longer periods in fan-only mode, this is normal operation. The intelligent logic of your machine will save you money.

WHAT DESIRED HUMIDITY SHOULD I SET THE DEHUMIDIFIER TO?

Unless you are using the unit to dry clothes, we recommend setting the desired humidity to between 50 and 60%.

For unoccupied properties, garages and etc, set the unit 60-70%RH with the fan in normal or sleep mode according to your needs. That will ensure minimum power consumption while preventing moisture-related issues.

THE ROOM HAS REACHED THE DESIRED HUMIDITY, BUT STILL HAVING PROBLEMS WITH CONDENSATION

If you find that you still have condensation on your windows or you need to dry the air further, set the unit to 40%RH or continuous mode with the fan set to turbo mode. This may be necessary if you have single glazed windows, the house is poorly insulated or if the outside air temperature drops towards freezing. Using the unit in turbo mode will add more heat to your room and reduce your heating bill as dry air will heat quicker

electriQ UK SUPPORT

For your own convenience, make these simple checks before calling the service line.

1. Has the unit been standing upright? (for at least 2 hrs)
2. Is the unit plugged into the mains? Is the fuse OK?
3. Switch the unit on and wait three minutes to see if the issue is resolved.
4. Check whether the water tank is full.
5. Have you followed the troubleshooting procedures?

If the unit still fails to operate call: 0330 390 3061 or fill in the online form

Office hours: 9AM - 5PM Monday to Friday

www.electriQ.co.uk

Unit 2A, Trident Business Park,
Neptune Way, Leeds Road, Huddersfield, HD2 1UA

DECLARATION OF CONFORMITY

Hereby, electriQ declares that this dehumidifier is in compliance with Directive 2014/53/EU. The full text of the EU declaration of conformity is available at the following internet address:

<https://www.electriQ.co.uk/content/declaration-of-conformity>

TECHNICAL DATA

Model No.	DESD8LW-V2
Rated Voltage	220-240V ~ 50Hz
Dehumidify Capacity	Max 8 L/Day (20°C RH60%)
Max Rated Input Power	610 W
Tank Capacity	2.0 litres
Air Volume	150 m ³ /h
Noise level	≤48 dB(A)
Net Weight	8.0 kg
All information provided is for reference only. Products specifications may change due to continuous product development.	

Disposal: Do not dispose of this product as unsorted waste. Collection of such waste must be handled separately as special treatment is necessary.



Recycling facilities are now available for all customers at which you can deposit your old electrical products. Customers will be able to take any old electrical equipment to participating sites run by their local councils. Please remember that this equipment will be further handled during the recycling process, so please be considerate when depositing your equipment. Please contact the local council for details of your local household waste recycling centre

V20232209